

TITLE: GERM SHIELD 36W x 30H	DATE: 04/17/20	DATE: 04/17/20	ORDER NO. XXXXX	PACKAGE SHEET: OF
	USED BY: T.HA	DESIGN BY:	CUSTOMER: FENCO	
	DRAWN BY: T.HA	T.HA		

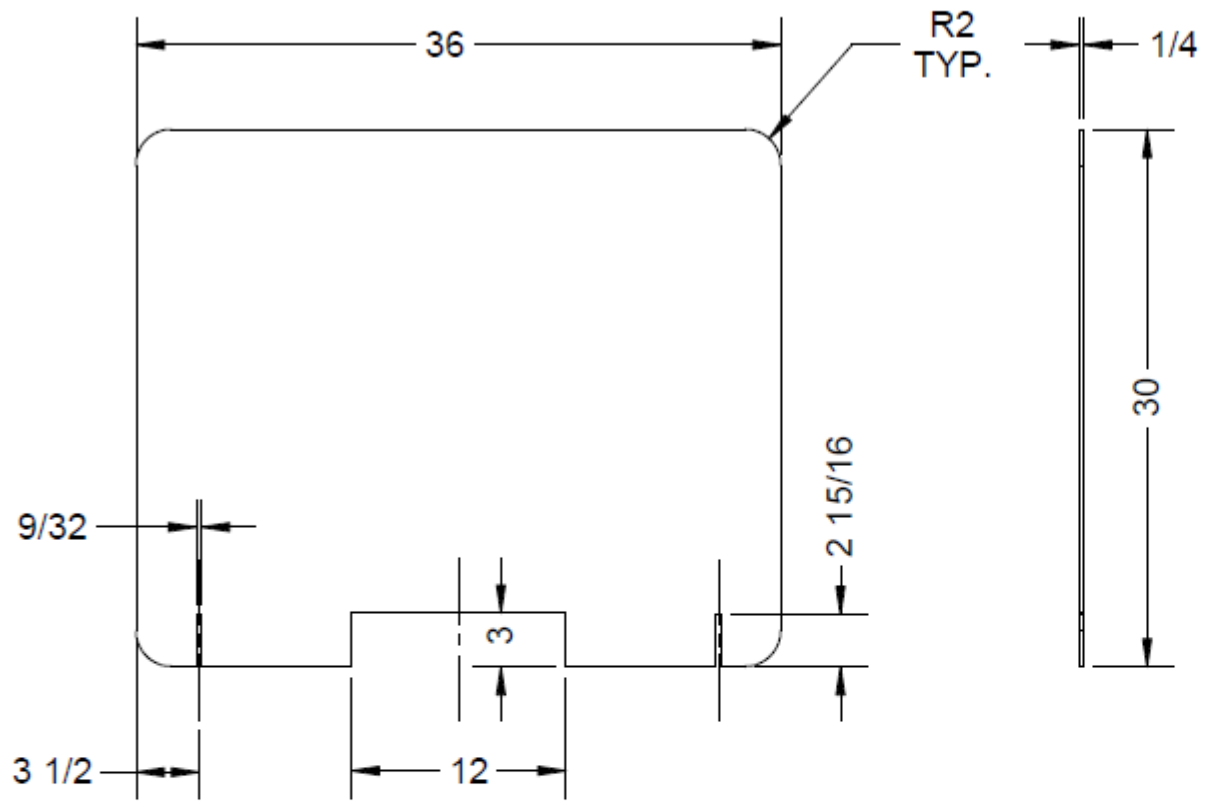

GERMSHIELD: 1/4" THICK POLYMER (1/ ASSY)

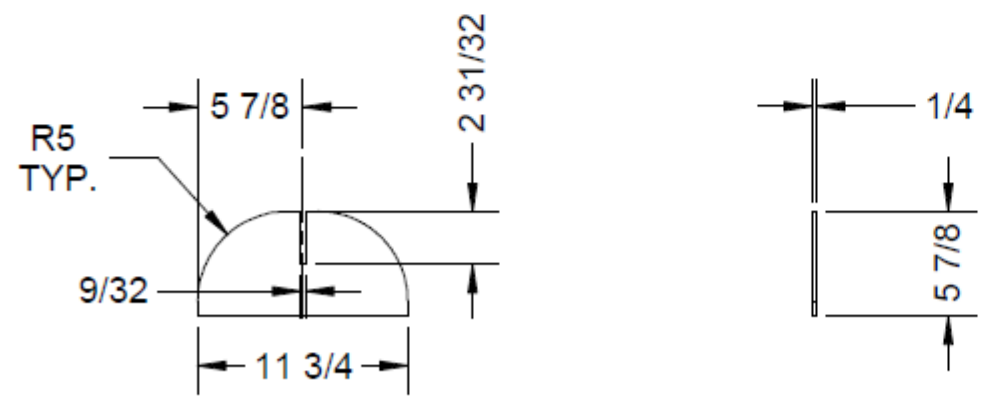

FEET: 1/4" THICK POLYMER (2/ASSY)

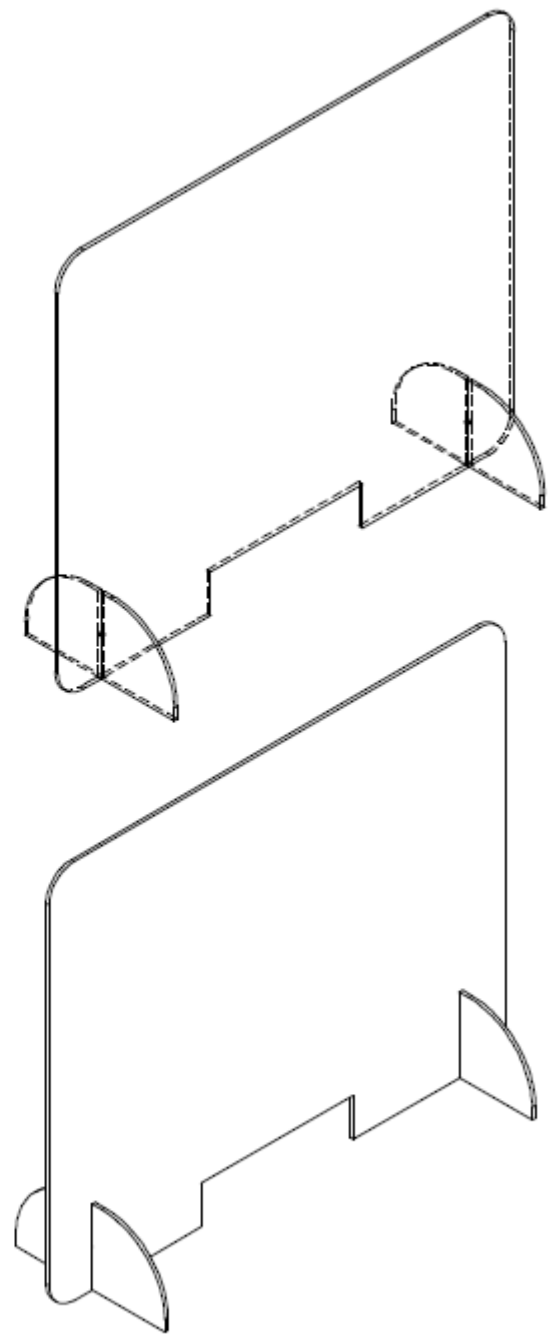

Last Update: 04/17/20 T.HA

**Fenco**  
Undercounter & Forecounter Equipment  
P.O. BOX 1238 BURLINGTON, NJ 08016-0516  
www.fencobankequipment.com