

WHETHER IT'S YOUR FIRST TIME OR YOUR NEXT TIME, WE MAKE IT EASY EVERY TIME:

Fenco Pods

VALUE BY DESIGN SINCE 1957

Step 1 - CHOOSE POD LAYOUT/STYLE: You'll find several popular designs on this flyer and our website to choose from. All our pod designs support a TCR and UCS. Upon request, we can fashion these to better suit your customer's needs (incorporate ADA stations, add shelving, pencil drawers, privacy panels, forms holders, ADA flip-up shelf, etc.). If you'd like to design a pod from the ground up, we can do that as well (provide a concept, image or sketch to get us started).

Step 2 - CHOOSE MATERIAL AND COLOR FINISH: Fenco partners with Wilson Art laminates, Corian solid surfaces and many other leading companies to provide the best color & surface choices to complement your branch's décor.

Step 3 - SUBMIT PO & FINALIZE DESIGN: Fenco will provide you with a quoted option & drawing based on your choice. If you like it, sign off on the drawings and provide a PO to place your order. If not, let us know what you'd like us to tweak until the design meets your approval.

Step 4 - DELIVERY & INSTALLATION: Typical lead-time after receipt of signed drawings is 4-6 weeks. In a rush? Depending on availability, we may be able to offer you a pod shipped in as little as 10 days from signed drawings. Fenco Pods ship completely or partially assembled via common carrier or Fenco's private truck from one of our many partner mills around the country. For partially assembled pods, we suggest you budget 2 installers 2-4 hours per pod (totaling 4-8 man hours), depending on complexity of pod. Most pods are fairly simple to assemble. If you'd like Fenco to arrange installation, please let us know.

CONTACT INFO: Mattjr@uhfenco.com or Larry.Williams@uhfenco.com * 800-486-8484 x 102 or 107 * www.FencoBankEquipment.com

POD "A"

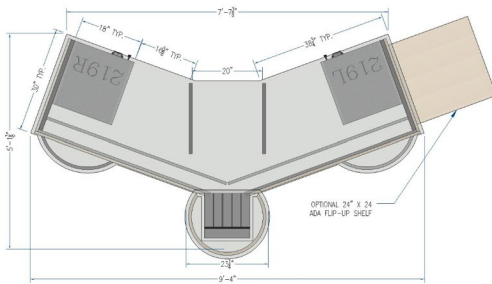

TOP VIEW
POD A

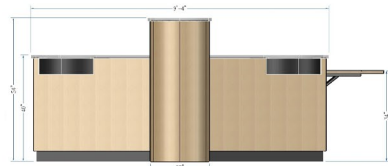

FRONT VIEW
POD A

OPTIONAL 36" W ADA FLIP-UP SHELF

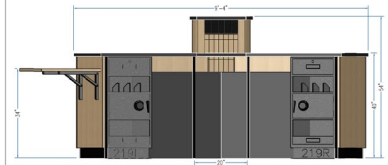

REAR VIEW
POD A



POD "B"

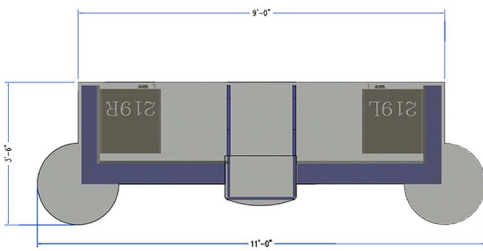

TOP VIEW
POD B

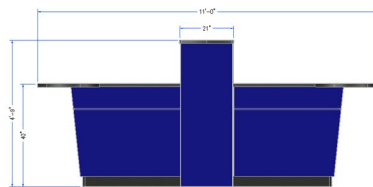

FRONT VIEW
POD B

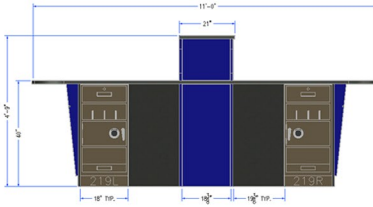

REAR VIEW
POD B

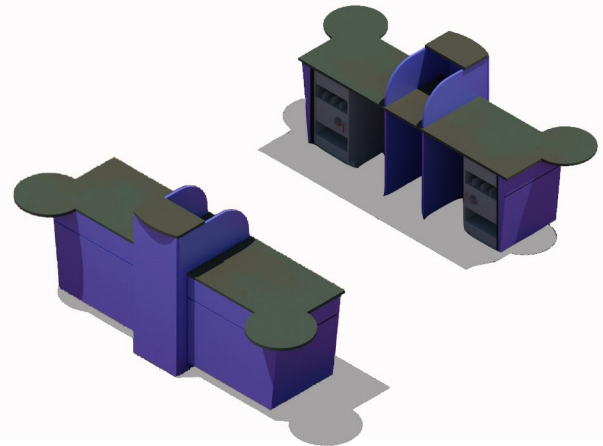

POD "C"

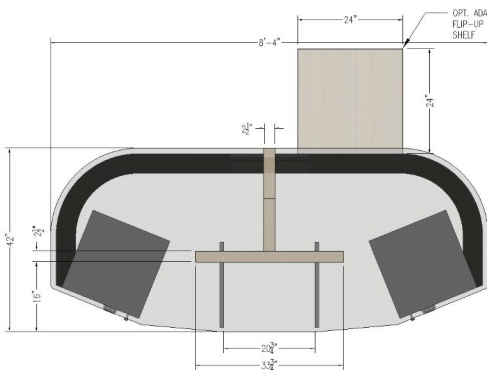

TOP VIEW
POD C

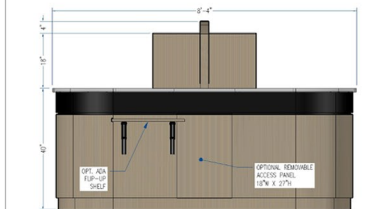

FRONT VIEW
POD C



REAR VIEW
POD C

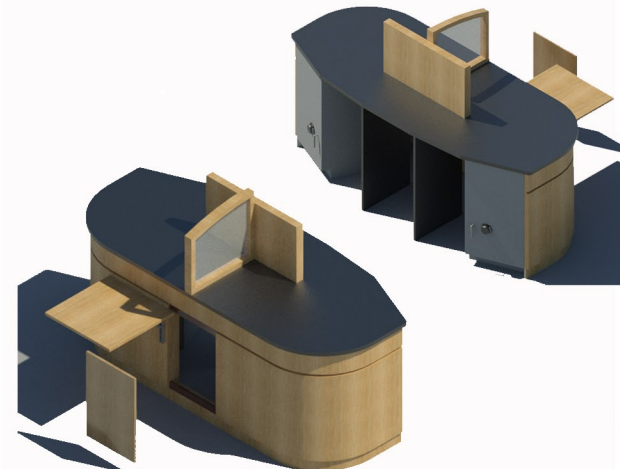

POD "D"

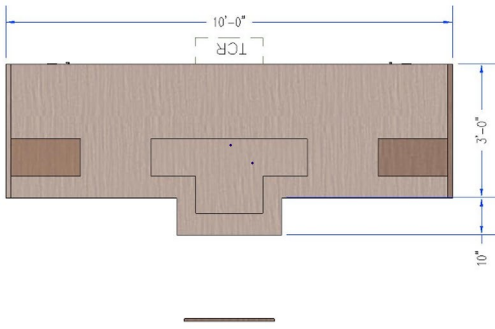

TOP VIEW
POD D

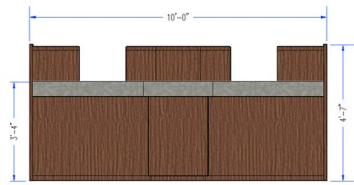

FRONT VIEW
POD D

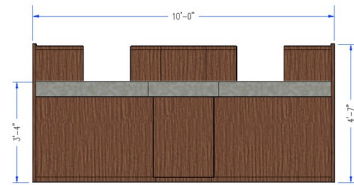

REAR VIEW
POD D

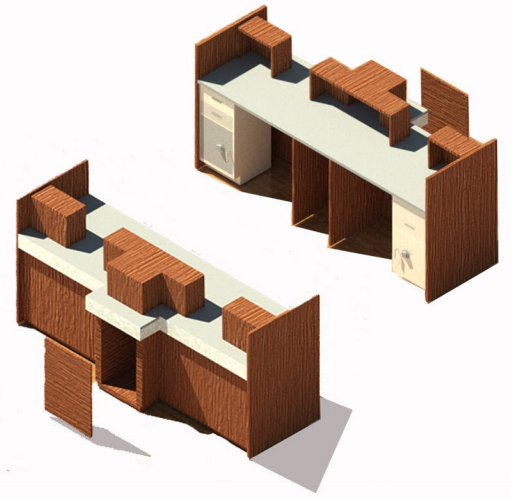

POD "E"

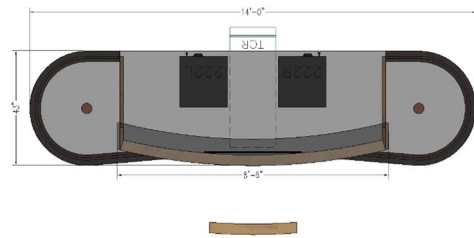

TOP VIEW
POD E



FRONT VIEW
POD E

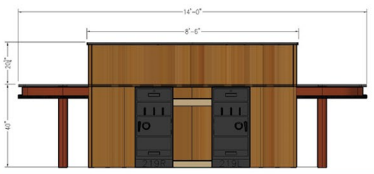

REAR VIEW
POD E



POD "F"

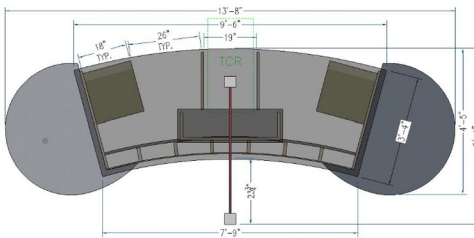

TOP VIEW
POD F

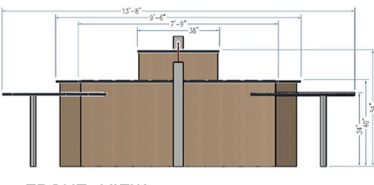

FRONT VIEW
POD F

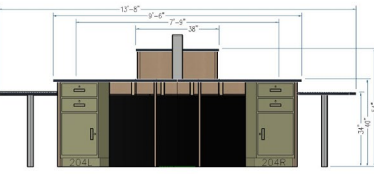

REAR VIEW
POD F

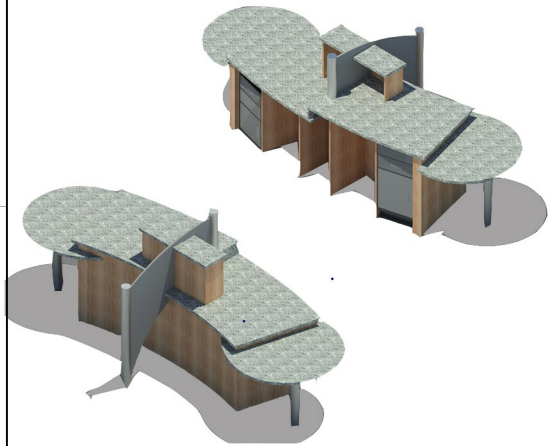

POD "Z"

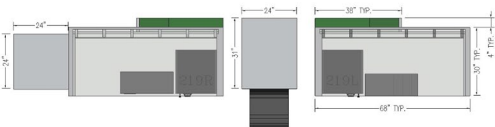

TOP VIEW
POD Z

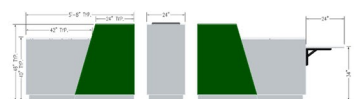

FRONT VIEW
POD Z

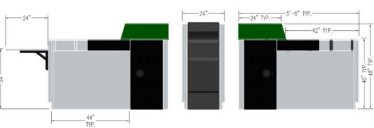

REAR VIEW
POD Z

