

PART NO.:	TITLE:	USED BY:	SCALE: NTS	ORDER NO.:	PACKAGE SHEET:	OF
SHEET: OF:	231-19	DATE:	DRN BY: Bolton T. DATE: 09/05/03	CUSTOMER: FENCO		

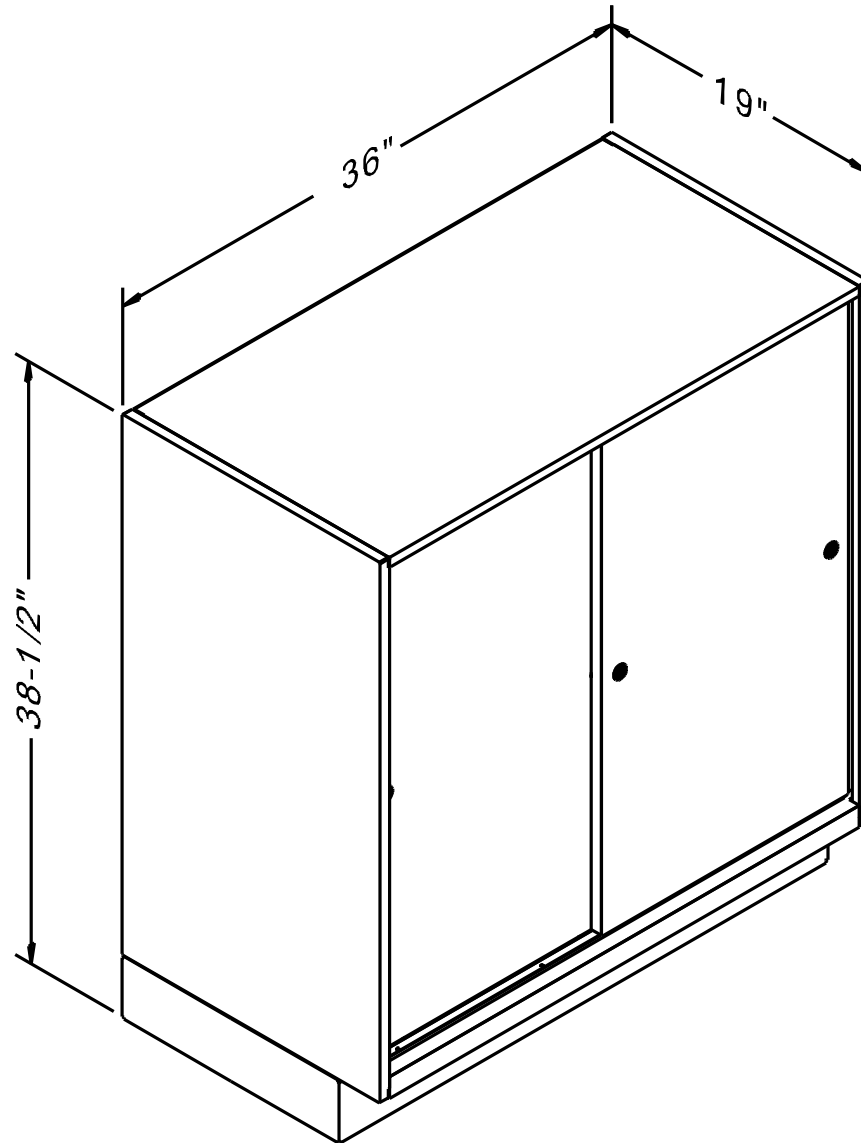

Last Update: 12/11/2007 - Bolton T.

Fenco
 Undercounter & Forecounter Equipment
 P.O. BOX 1238 BURLINGTON, NJ 08016-0516
www.fencobankequipment.com