

PART NO:	TITLE: S-206	USED BY:	SCALE:	ORDER NO. -	PACKAGE SHEET: OF
SHEET: OF		DATE:	DRN BY: Bolton T. DATE: 03/10/10	CUSTOMER: FENCO	

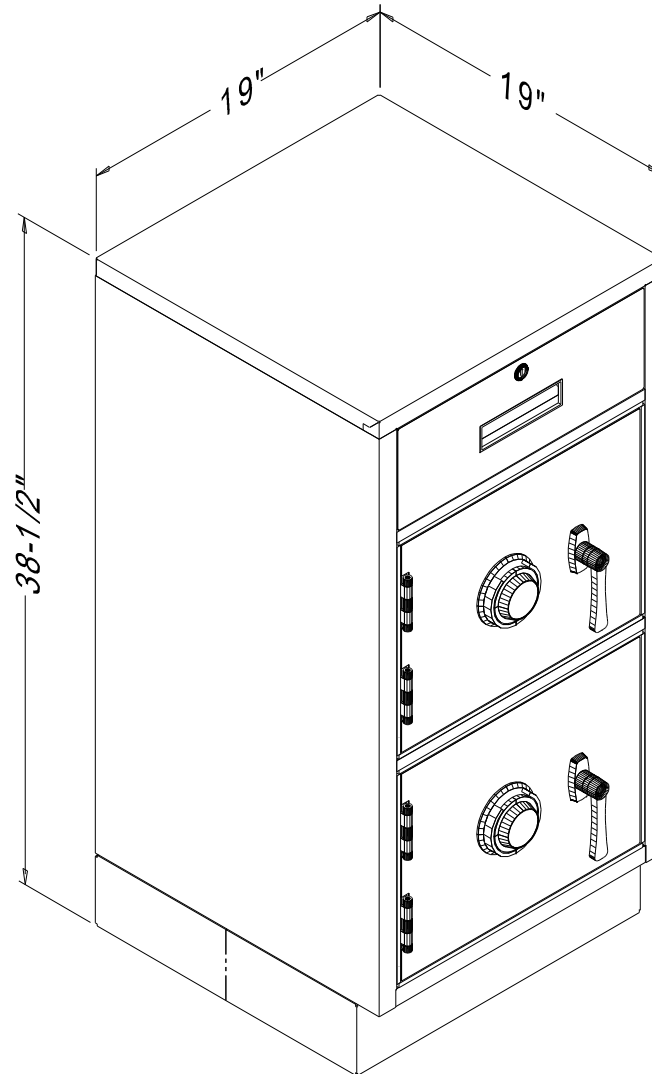

Last Update: 08/28/2013 - Bolton T.

Fenco
 Undercounter & Forecounter Equipment
 P.O. BOX 1238 BURLINGTON, NJ 08016-0516
www.fencobankequipment.com