

PART NO:	TITLE:	USED BY:	SCALE:	ORDER NO.:	PACKAGE SHEET: OF
SHEET: OF	251-19	DATE:	DRN BY: Bolton T. DATE: 08/02/04	CUSTOMER:	FENCO

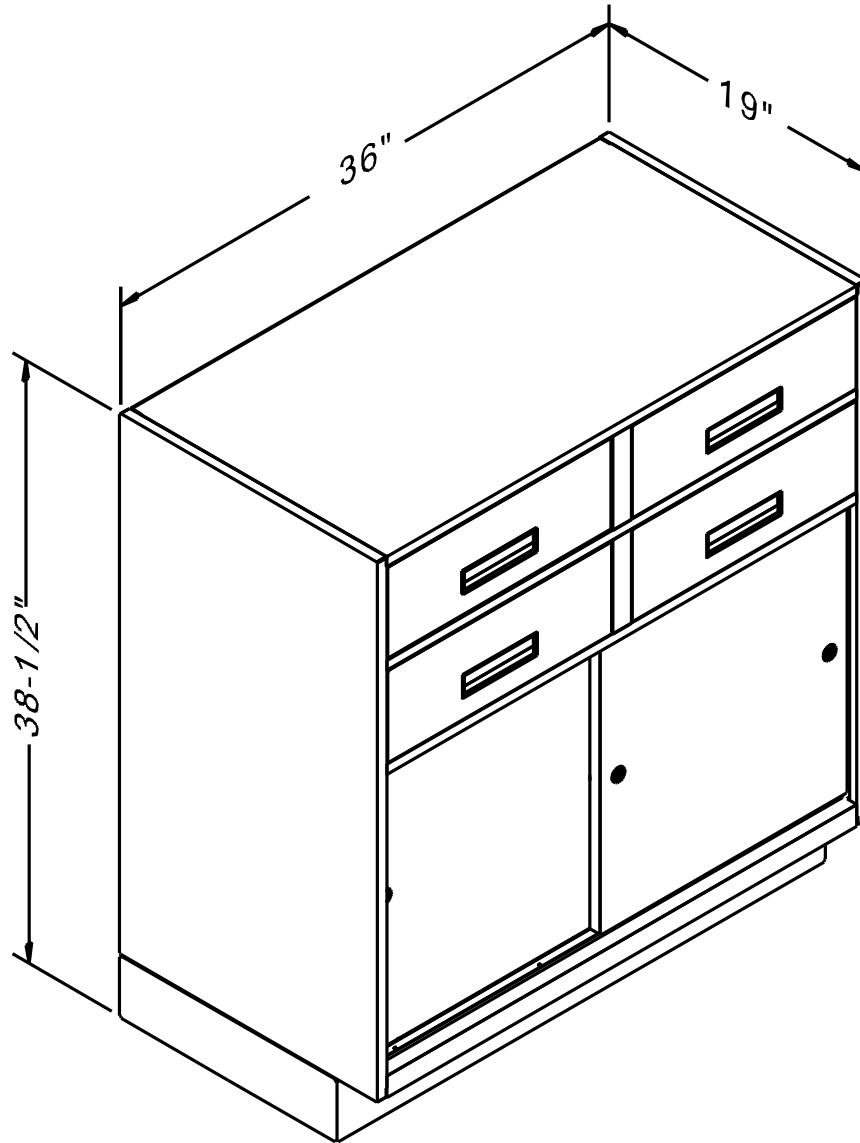

Last Update: 12/11/2007 - Bolton T.



Fenco

Undercounter & Forecounter Equipment
P.O. BOX 1238 BURLINGTON, NJ 08016-0516
www.fencobankequipment.com